

Commercial Thermostats



DESCRIPTION

Thermostats can provide either temperature control or over-temperature protection by breaking electrical contact when a specified temperature is reached.

Honeywell manufactures a wide range of 12,7 mm [0.5 in] commercial snap-action thermostats for possible use in a wide array of small and major appliances, office copy machines, medical equipment, heat detectors, HVAC equipment and more.

These snap-action thermostats include automatic and manual reset options, phenolic or ceramic housings and a wide variety of mounting brackets and terminal options.

Each thermostat's design is configured from a base unit, and may be customized for temperature tolerance and mechanical configurations, meeting the customer's needs for accuracy and exactitude.

Honeywell can also integrate these thermostats in higher value cable assemblies, incorporating wire harness and connectors.

TABLE OF CONTENTS

| | |
|---|-------|
| DESCRIPTION | p. 1 |
| NOMENCLATURE | p. 2 |
| DEFINITION OF TERMS | p. 3 |
| NOTES | p. 3 |
| COMMERCIAL THERMOSTATS | |
| 2450R/2450HR/2455R/2452R/2452HR Series Phenolic Automatic Reset | p. 4 |
| 2450RC/2450RCH/2455RC Series Ceramic Automatic Reset | p. 6 |
| 2455RM/2450CM Series Phenolic or Ceramic Manual Reset | p. 9 |
| 2455RD Series Phenolic Manual Reset | p. 11 |
| 2455RBV Series Overmolded Automatic Reset | p. 13 |
| 2450A/2455RA Series Heat Detection | p. 15 |
| 2450R/2455R/2450RC/2455RC/2450HR/2450RCH Series "One Shot" | p. 17 |
| REDI-TEMP THERMOSTATS | |
| 3455RC Series | p. 19 |
| MOUNTING HARDWARE | |
| Brackets | p. 20 |
| Brass mounting studs | p. 21 |
| Terminals | p. 22 |

Commercial Thermostats

NOMENCLATURE

The nomenclature given in Figure 1 is provided for reference only.

Figure 1. Commercial Thermostat Nomenclature

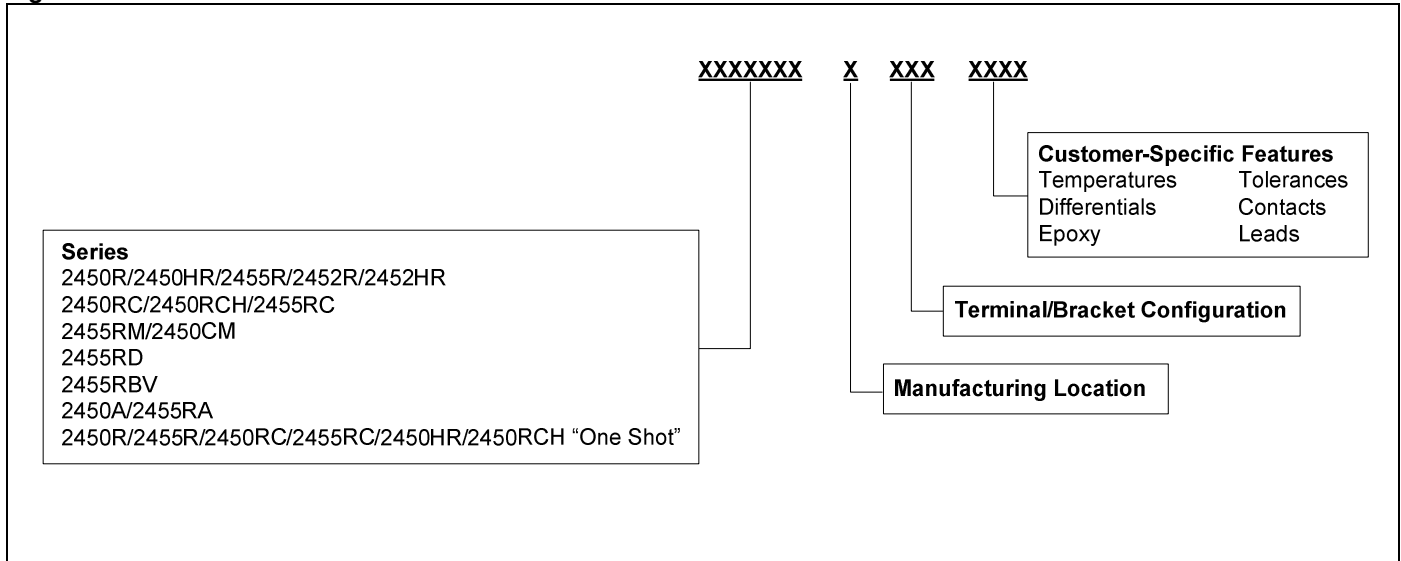

DEFINITION OF TERMS

- **Automatic Reset:** A type of thermostat that will automatically reset at a specific temperature (i.e. a thermostat operates at 65,5 °C [150 °F] and resets at 48,89 °C [120 °F]).
- **Bimetal:** Two dissimilar metals bonded together to form the material for manufacturing thermally-sensitive discs which actuate the thermostat.
- **Close on Rise (COR):** Refers to operation of the contacts. When the temperature rises to its set point, the contacts close or make contact and complete the circuit.
- **Contact Resistance:** The value of resistance measured between the terminals.
- **Dielectric Strength:** The value of insulation between two electrically conducting parts. It may be tested by the application of a predetermined overvoltage for a specified time.
- **Differential:** The temperature difference between the operate and reset set points, also known as operate and reset.
 - **Nominal:** The temperature difference between nominal set points regardless of tolerance.
 - **Maximum:** Maximum number of degrees between actual opening and closing set points.
 - **Minimum:** Minimum number of degrees between actual opening and closing set points.
- **Exposure Temperature:** Thermal environment of a device during application operation.
- **FLA (Full Load Amps):** Current taken from the line by the motor when the motor is yielding the rated hp at the rated voltage and frequency.
- **Life Cycles:** The endurance rating of the thermostat expressed in number of operations with stated electrical load applied. Temperature limit application = open on rise.
- **LRA (Locked Rotor Amps):** The amount of current the motor can be expected to draw under starting conditions when full voltage is applied, also known as starting inrush current.
- **Manual Reset:** A bimetal thermostat with a reset button that must be pressed to reset the contacts.
- **Open on Rise (OOR):** Refers to the operation of contacts. When the temperature rises to its set point the contacts open, terminating the circuit.
- **Overmold:** Encapsulation with an insulating material.
- **Phenolic:** Thermoset plastic used for the insulating body of the thermostat.
- **Set Point:** The nominal temperature at which the thermostat operates.
- **SPST (Single Pole/Single Throw):** A switch with one current path which can be either open or closed.
- **Tolerance:** The allowable range above and below the set point temperature.
- **Operate:** Change of state when the thermostat reaches its set point.
- **Reset:** Change of state when the thermostat returns to its original condition prior to operation.

NOTES

- **Standard Temperature Characteristics Tables:**
 - **Temperatures:** Please consult applications engineering for temperature ranges, tolerances and differentials not noted. The operating temperature ranges include tolerances.
 - **Tolerances:** The \pm tolerances given have been established after review of many thermostat applications. Attempts should be made to establish the widest acceptable tolerance possible.
- **UL and CSA Approvals:** 12,7 mm [0.5 in] thermostats are available with multiple agency approval for incorporation into equipment.
- **Fan control applications:** Require thermostat set points to be derated by 20 °C from the equivalent temperature limit application. They also close on rise.
- **Dimensions:** Are for reference only and are given in mm [in].

Commercial Thermostats

Figure 2. 2450R/2450HR/2455R/2452R/2452HR Series Phenolic Automatic Reset Thermostat



The 2450R/2450HR/2455R/2452R/2452HR Series is a single pole, single throw, snap-acting, non-adjustable thermostat which may be used in applications such as power supplies, general appliances and medical equipment. A temperature-sensitive bimetal disc, electrically and thermally isolated from the switch, is used to actuate the normally-closed contacts. Contacts open when surface or ambient temperatures increase to the operating set point of the calibrated bimetal disc. The entire switch is enclosed in a phenolic housing; the bimetal disc is retained by a metal heat-conducting end cap. Due to the small size of this unit and the inherently low mass of the bimetal snap-action disc, response of this thermostat to temperature changes is extremely rapid, compared to other commercially available thermostatic devices. A variety of mounting brackets and terminals are available.

All versions are UL/CSA approved. The 2452R/2452HR/2455R version meets the requirements of EN60730-01.

Potential applications include:

- Power supplies
- Appliances
- Medical equipment
- Water heaters
- Office automation
- Industrial equipment
- HVAC equipment

Table 1. 2450R/2450HR/2455R/2452R/2452HR Series Standard Temperature Characteristics

| Operating Temperature Range | Tolerance | | Standard Mean Differential °C [°F] |
|--|-----------------|------------------|---------------------------------------|
| | Open °C [°F] | Close °C [°F] | |
| 0 °C to 26 °C [32 °F to 79 °F] | ±4 [±7] | ±6 [±10] | 28 to 34 [50 to 60] |
| | ±4 [±6] | ±6 [±10] | 22 to 27 [40 to 49] |
| | ±4 [±6] | ±5 [±9] | 17 to 22 [30 to 39] |
| | ±4 [±6] | ±5 [±8] | 14 to 16 [25 to 29] |
| | ±3 [±5] | ±5 [±8] | 8 to 14 [15 to 24] |
| 27 °C to 82 °C [80 °F to 180 °F] | ±5 [±9] | ±8 [±15] | 45 to 56 [81 to 100] |
| | ±4 [±7] | ±6 [±11] | 34 to 45 [61 to 80] |
| | ±4 [±6] | ±6 [±10] | 28 to 34 [50 to 60] |
| | ±3 [±5] | ±6 [±10] | 22 to 27 [40 to 49] |
| | ±3 [±5] | ±5 [±9] | 17 to 22 [30 to 39] |
| 83 °C to 110 °C [181 °F to 230 °F] | ±6 [±10] | ±8 [±15] | 45 to 56 [81 to 100] |
| | ±5 [±8] | ±8 [±15] | 34 to 45 [61 to 80] |
| | ±4 [±7] | ±7 [±12] | 28 to 34 [50 to 60] |
| | ±4 [±6] | ±6 [±10] | 22 to 27 [40 to 49] |
| | ±4 [±6] | ±5 [±9] | 17 to 22 [30 to 39] |
| | ±4 [±6] | ±5 [±8] | 8 to 16 [15 to 29] |
| 111 °C to 150 °C [231 °F to 302 °F] | ±7 [±12] | ±10 [±18] | 45 to 56 [80 to 100] |
| | ±5 [±9] | ±8 [±15] | 34 to 45 [61 to 80] |
| | ±5 [±8] | ±7 [±12] | 28 to 34 [50 to 60] |
| | ±4 [±7] | ±7 [±12] | 22 to 27 [40 to 49] |
| | ±4 [±7] | ±6 [±11] | 17 to 22 [30 to 39] |
| | ±4 [±7] | ±6 [±10] | 14 to 16 [25 to 29] |

Table 2. 2450R/2450HR/2455R/2452R/2452HR Series Specifications

| Characteristic | Parameter |
|------------------------------|---|
| Switch type | SPST |
| Reset type | automatic |
| Amperage | See Tables 3, 4 |
| Voltage | 120 Vac to 250 Vac |
| Operating temperature range | 0 °C to 150 °C [32 °F to 302 °F] |
| Environmental exposure range | -18 °C to 177 °C [0 °F to 350 °F] |
| Materials: | |
| Base | phenolic |
| Contacts | silver alloy |
| Terminals | unplated brass, plated brass or steel |
| Closure | aluminum, brass or stainless steel |
| Brackets | aluminum or stainless steel |
| UL and CSA approvals | <ul style="list-style-type: none"> • 2455R: 6,35 mm [0.25 in] clearance; UL File MH8267, UL File E36103; CSA File LR21048 • 2450HR: 1,59 mm [0.0625 in] clearance; UL File E36103; CSA File LR21048 • 2450R: 1,59 mm [0.0625 in] clearance; UL File E36103; CSA File LR 21048 • 2452R: 2.66mm [0.105 in] clearance; UL E36103 • 2452HR: 2.66mm [0.105 in] clearance; UL36103 |
| Weight | 6 g [0.2 oz] (does not include brackets or wire leads) |

Table 3. 2450R/2450HR/2452R/2452HR Contact Ratings

| Life Cycles | 120 Vac | 240 Vac | 277 Vac |
|-------------|-------------------|-------------------|----------------|
| 100,000 | 15 A resistive | 10 A resistive | 10 A resistive |
| 30,000 | 125 VA pilot duty | 125 VA pilot duty | - |

Note: 2450 approval rating is limited by EN60730-1 to 125 Vac max.

Table 4. 2455R Contact Ratings

| Life Cycles | 120 Vac | 240 Vac | 277 Vac |
|-------------|---|---|-----------------|
| 100,000 | 15 A resistive 4.4 FLA 26.4 LRA 125 VA pilot duty | 10 A resistive 2.2 FLA 13.2 LRA 125 VA pilot duty | 7.2 A resistive |
| 6,000 | 5.8 FLA, 34.8 LRA | 2.9 FLA, 17.4 LRA | - |

Note: Additional contact ratings are available, please contact Honeywell.

Figure 3. 2450R/2450HR/2455R/2452R/2452HR Basic Dimensions

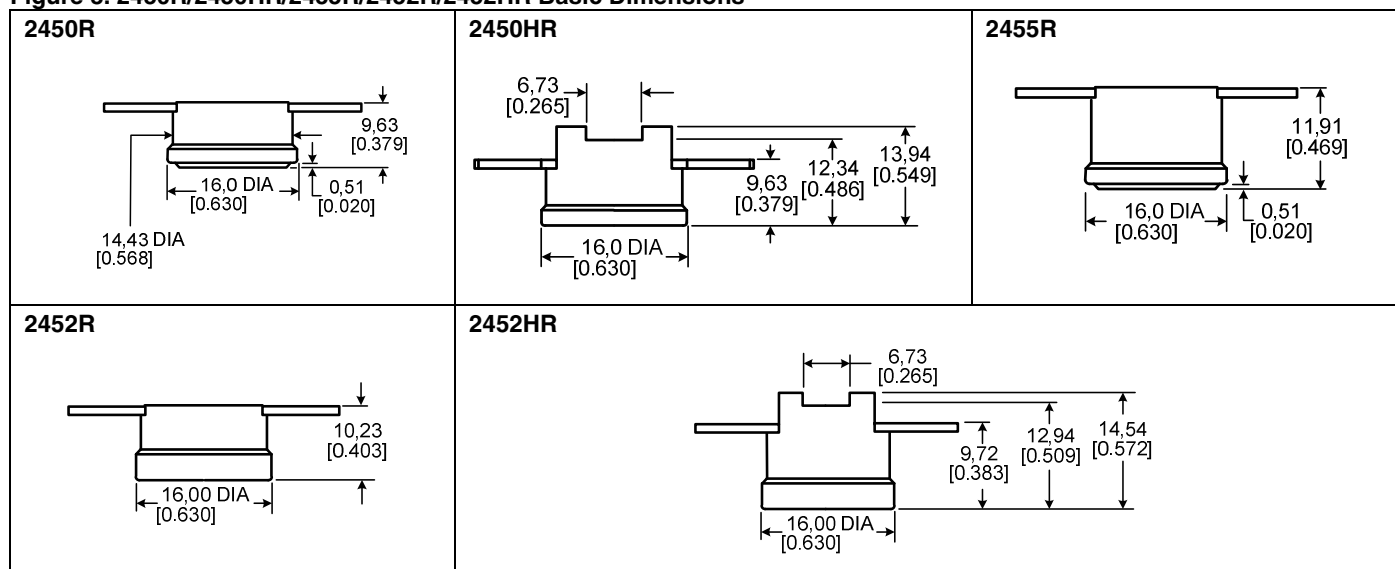

Commercial Thermostats

Figure 4. 2450RC/2450RCH/2455RC Series Automatic Reset Thermostat



The 2450RC/2450RCH/2455RC Series is a single pole, single throw, snap-acting, non-adjustable thermostat which may be used in applications such as industrial and electrical equipment. A temperature-sensitive bimetal disc, electrically and thermally isolated from the switch, is used to actuate the normally-closed contacts. Contacts open when surface or ambient temperatures increase to the operating set point of the calibrated metal disc. The entire switch is enclosed in a ceramic housing; the bimetal disc is retained by a metal heat-conducting end cap. Due to the small size of this unit and the inherently low mass of the bimetal snap-action disc, response of this thermostat to temperature changes is extremely rapid, compared to other commercially available thermostatic devices. For increased sensitivity, an exposed bimetal disc may be specified. A variety of mounting brackets and terminals is available.

All versions are UL/CSA and European approved.

Potential applications include high temperature control for:

- Power supplies
- Appliances
- Medical equipment
- Water heaters
- Office automation
- Industrial equipment
- HVAC equipment

Table 5. 2450RC/2450RCH/2455RC Series Standard Temperature Characteristics

| Operating Temperature Range | Tolerance | | Standard Mean Differential °C [°F] |
|---------------------------------------|-----------------|------------------|---------------------------------------|
| | Open °C [°F] | Close °C [°F] | |
| 0 °C to 26 °C [32 °F to 79 °F] | ±4 [±7] | ±6 [±10] | 28 to 34 [50 to 60] |
| | ±4 [±6] | ±6 [±10] | 22 to 27 [40 to 49] |
| | ±4 [±6] | ±5 [±9] | 17 to 22 [30 to 39] |
| | ±4 [±6] | ±5 [±8] | 14 to 16 [25 to 29] |
| | ±3 [±5] | ±5 [±8] | 8 to 14 [15 to 24] |
| 27 °C to 82 °C [80 °F to 180 °F] | ±5 [±9] | ±8 [±15] | 45 to 56 [81 to 100] |
| | ±4 [±7] | ±6 [±11] | 34 to 45 [61 to 80] |
| | ±4 [±6] | ±6 [±10] | 28 to 34 [50 to 60] |
| | ±3 [±5] | ±6 [±10] | 22 to 27 [40 to 49] |
| | ±3 [±5] | ±5 [±9] | 17 to 22 [30 to 39] |
| 83 °C to 110 °C [181 °F to 230 °F] | ±3 [±5] | ±5 [±8] | 8 to 16 [15 to 29] |
| | ±6 [±10] | ±8 [±15] | 45 to 56 [81 to 100] |
| | ±5 [±8] | ±8 [±15] | 35 to 45 [61 to 80] |
| | ±4 [±7] | ±7 [±12] | 28 to 34 [50 to 60] |
| | ±4 [±6] | ±6 [±10] | 22 to 27 [40 to 49] |
| | ±4 [±6] | ±5 [±9] | 17 to 22 [30 to 39] |
| | ±4 [±6] | ±5 [±8] | 8 to 16 [15 to 29] |

Table 6. 2450RC/2450RCH/2455RC Series Standard Temperature Characteristics (continued)

| Operating Temperature Range | Tolerance | | Standard Mean Differential °C [°F] |
|--|-----------------|------------------|---------------------------------------|
| | Open °C [°F] | Close °C [°F] | |
| 111 °C to 149 °C [231 °F to 300 °F] | ±7 [±12] | ±10 [±18] | 45 to 56 [81 to 100] |
| | ±5 [±9] | ±8 [±15] | 34 to 45 [61 to 80] |
| | ±5 [±8] | ±7 [±12] | 28 to 34 [50 to 60] |
| | ±4 [±7] | ±7 [±12] | 22 to 27 [40 to 49] |
| | ±4 [±7] | ±6 [±11] | 17 to 22 [30 to 39] |
| | ±4 [±7] | ±6 [±10] | 14 to 16 [25 to 29] |
| 150 °C to 170 °C [301 °F to 335 °F] | ±8 [±15] | ±11 [±20] | 39 to 45 [71 to 80] |
| | ±6 [±10] | ±11 [±20] | 34 to 39 [61 to 70] |
| | ±6 [±10] | ±8 [±15] | 28 to 33 [50 to 60] |
| | ±6 [±10] | ±7 [±12] | 22 to 27 [40 to 49] |
| 171 °C to 220 °C [336 °F to 425 °F] | ±14 [±25] | ±14 [±25] | 51 to 56 [91 to 100] |
| | ±11 [±20] | ±11 [±20] | 39 to 50 [71 to 90] |
| | ±8 [±15] | ±11 [±20] | 28 to 39 [50 to 70] |
| 221 °C to 235 °C [426 °F to 450 °F] | ±14 [±25] | ±14 [±25] | 51 to 56 [91 to 100] |
| | ±11 [±20] | ±11 [±20] | 39 to 50 [71 to 90] |
| | ±8 [±15] | ±11 [±20] | 28 to 39 [50 to 70] |
| 236 °C to 260 °C [451 °F to 500 °F] | ±14 [±25] | ±14 [±25] | 31 to 56 [60 to 100] |
| | ±11 [±20] | ±11 [±20] | 28 to 50 [50 to 90] |

Table 7. 2450RC/2450RCH/2455RC Series Specifications

| Characteristic | Parameter |
|------------------------------|---|
| Switch type | SPST |
| Reset type | automatic |
| Amperage | See Tables 8, 9 |
| Voltage | 120 Vac to 250 Vac |
| Operating temperature range | 0 °C to 260 °C [32 °F to 500 °F] |
| Environmental exposure range | -20 °C to 287 °C [0 °F to 550 °F] |
| Materials: | |
| Base | ceramic |
| Contacts | silver alloy |
| Terminals | plated steel |
| Closure | aluminum, brass, or stainless steel |
| Brackets | stainless steel |
| Approvals | <ul style="list-style-type: none"> • 2450RCH: 1,59 mm [0.0625 in] clearance through air and over surface; UL File E36103; CSA File LR21048 • 2450RC: 1,59 mm [0.0625 in] clearance; UL file E36103; CSA File LR21048 • 2455RC: 6,35 mm [0.25 in] clearance; UL File E36103; CSA File LR21048 |
| Weight | 6 g [0.21 oz] (does not include brackets or wire leads) |

Commercial Thermostats

Table 8. 2450RCH/2450RC Contact Ratings

| Life Cycles | 120 Vac | 240 Vac |
|-------------|-------------------|-------------------|
| 100,000 | 15 A resistive | 10 A resistive |
| 30,000 | 125 VA pilot duty | 125 VA pilot duty |

Table 9. 2455RC Contact Ratings

| Life Cycles | 120 Vac | 240 Vac |
|-------------|-------------------|-------------------|
| 100,000 | 15 A resistive | 10 A resistive |
| 100,000 | 4.4 FLA 26.4 LRA | 2.2 FLA 13.2 LRA |
| 100,000 | 125 VA pilot duty | 125 VA pilot duty |

Note: Additional contact ratings are available, please contact Honeywell.

Figure 5. 2450RC/2450RCH/2455RC Basic Dimensions



Figure 6. 2455RM/2450CM Series Phenolic or Ceramic Manual Reset Thermostats



The 2455RM (phenolic)/2450CM (ceramic) Series is a single pole, single throw, snap-acting, non-adjustable thermostat. A temperature-sensitive bimetal disc, electrically and thermally isolated from the switch, is used to actuate the normally-closed contacts. Contacts open when surface or ambient temperatures increase to the operating set point of the calibrated bimetal disc. The entire switch is enclosed in a housing; the bimetal disc is retained by a metal heat-conducting end cap. The circuit remains open above the room ambient temperature until the manual reset button is depressed. Due to the small size of this unit and the inherently low mass of the bimetal snap-action disc, response of this thermostat to temperature changes is extremely rapid, compared to other commercially available thermostatic devices. For increased sensitivity, an exposed bimetal disc may be specified. A variety of mounting brackets and terminals is available.

All versions are UL/CSA, European approved.

Potential applications include those where a manual reset is desired, including:

- Power supplies
- Appliances
- Medical equipment
- Water heaters
- Office automation
- Industrial equipment
- HVAC equipment

Table 10. 2455RM Series Standard Temperature Characteristics

| Operating Temperature Range | Tolerance °C [°F] |
|-------------------------------------|-------------------|
| 52 °C to 93 °C [125 °F to 200 °F] | ±5 [±8] |
| 94 °C to 121 °C [201 °F to 250 °F] | ±6 [±10] |
| 122 °C to 150 °C [251 °F to 302 °F] | ±7 [±12] |

Table 11. 2450CM Series Standard Temperature Characteristics

| Operating Temperature Range | Tolerance °C [°F] |
|-------------------------------------|-------------------|
| 52 °C to 93 °C [125 °F to 200 °F] | ±5 [±8] |
| 94 °C to 121 °C [201 °F to 250 °F] | ±6 [±10] |
| 122 °C to 149 °C [251 °F to 300 °F] | ±7 [±12] |
| 150 °C to 177 °C [301 °F to 350 °F] | ±8 [±15] |
| 177 °C to 204 °C [351 °F to 400 °F] | ±10 [±18] |
| 205 °C to 232 °C [401 °F to 450 °F] | ±11 [±20] |

Commercial Thermostats

Table 12. 2455RM/2450CM Series Specifications

| Characteristic | Parameter |
|------------------------------|--|
| Switch type | SPST |
| Reset type | manual |
| Amperage | 15 A resistive at 6,000 cycles (UL); 16 A resistive at 1000 cycles (EU) |
| Voltage | 120 Vac to 250 Vac |
| Operating temperature range | 2455RM: 52 °C to 150 °C [125 °F to 302 °F] 2450CM: 52 °C to 232 °C [125 °F to 450 °F] |
| Environmental exposure range | 2455RM: -20 °C to 177 °C [0 °F to 350 °F] 2450CM: -20 °C to 260 °C [0 °F to 500 °F] |
| Materials: | |
| Base | 2455RM: phenolic; 2450CM: ceramic |
| Contacts | silver alloy |
| Terminals | 2455RM: unplated brass, plated brass or steel; 2450CM: plated steel |
| Closure | aluminum, brass, or stainless steel |
| Brackets | stainless steel |
| Approvals | UL File E36103, CSA File LR21048 |
| Weight | 6 g [0.21 oz] (does not include brackets or wire leads) |

NOTICE

- 2455RM/2450CM thermostats are intended as a manual reset control. They are not to be used on applications where a limit thermostat is required unless back-up protection is provided. Units have been tested by UL for 1,000 cycles under load, 5,000 cycles no load, and are not considered as limit devices.
- This range of thermostats has an automatic reset function with manual override function.
- Reset pin operation should not be performed above 70% of set point temperature.

Table 13. 2450CM/2455RM Contact Ratings

| Life Cycles | 120 Vac | 240 Vac |
|-------------|---------------------------------------|---------------------------------------|
| 6,000 | 15 A resistive | 10 A resistive |
| 6,000 | 4.4 FLA 26.4 LRA 125 VA pilot duty | 2.2 FLA 13.2 LRA 125 VA pilot duty |

Note: Additional contact ratings are available, please consult Honeywell.

Figure 7. 2455RM/2455CM Basic Dimensions

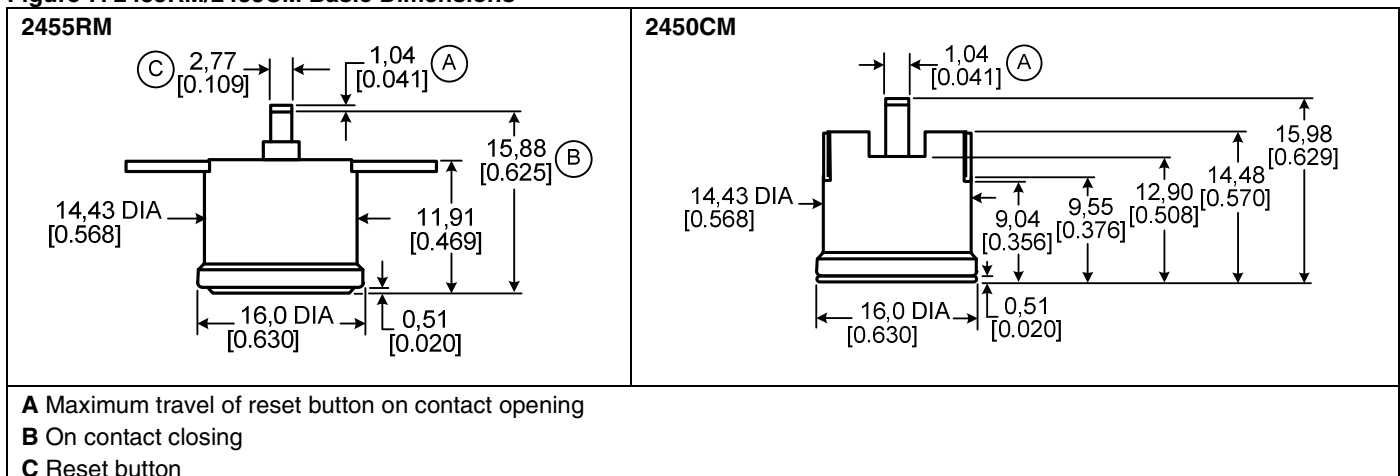

Figure 8. 2455RD Series Phenolic Manual Reset



The 2455RD Series is a single pole, single throw, snap-acting, non-adjustable thermostat. A temperature-sensitive bimetal disc, electrically and thermally isolated from the switch, is used to actuate the normally-closed contacts. Contacts open when surface or ambient temperatures increase to the operating set point of the calibrated bimetal disc. The entire switch is enclosed in a housing; the bimetal disc is retained by a metal heat-conducting end cap. The circuit remains open above the room ambient temperature until the manual reset button is depressed. (These devices are constructed with an additional steel disc so that they are manual reset only. They do not have an automatic reset.) Due to the small size of this unit and the inherently low mass of the bimetal snap-action disc, response of this thermostat to temperature changes is extremely rapid, compared to other commercially available thermostatic devices. For increased sensitivity, an exposed bimetal disc may be specified. A variety of mounting brackets and terminals is available.

All versions are UL/CSA and European approved.

Potential applications include those where a manual reset is desired, including:

- Power supplies
- Appliances
- Medical equipment
- Water heaters
- Office automation
- Industrial equipment
- HVAC equipment

Table 14. 2455RD Series Standard Temperature Characteristics

| Operating Temperature Range | Tolerance °C [°F] |
|-------------------------------------|-------------------|
| 52 °C to 93 °C [125 °F to 200 °F] | ±5 [±8] |
| 94 °C to 121 °C [201 °F to 250 °F] | ±6 [±10] |
| 122 °C to 150 °C [251 °F to 302 °F] | ±7 [±12] |

Commercial Thermostats

Table 15. 2455RD Series Specifications

| Characteristic | Parameter |
|------------------------------|---|
| Switch type | SPST |
| Reset type | manual |
| Amperage | 15 A resistive at 6,000 cycles (UL); 16 A resistive at 1000 cycles (EU) |
| Voltage | 120 Vac to 250 Vac |
| Operating temperature range | 2455RD: 52 °C to 150 °C [125 °F to 302 °F] |
| Environmental exposure range | 2455RD: -20 °C to 177 °C [0 °F to 350 °F] |
| Materials: | |
| Base | phenolic |
| Contacts | silver alloy |
| Terminals | unplated brass, plated brass or steel |
| Closure | aluminum, brass, or stainless steel |
| Brackets | stainless steel |
| Approvals | UL File E36103, CSA File LR21048 |

Table 16. 2455RD Contact Ratings

| Life Cycles | 120 Vac | 240 Vac |
|-------------|----------------|----------------|
| 6000 | 15 A resistive | 10 A resistive |

Note: Additional contact ratings are available, please consult Honeywell.

Figure 9. 2455RD Basic Dimensions



Figure 10. Series 2455RBV Overmolded Automatic Reset Thermostats

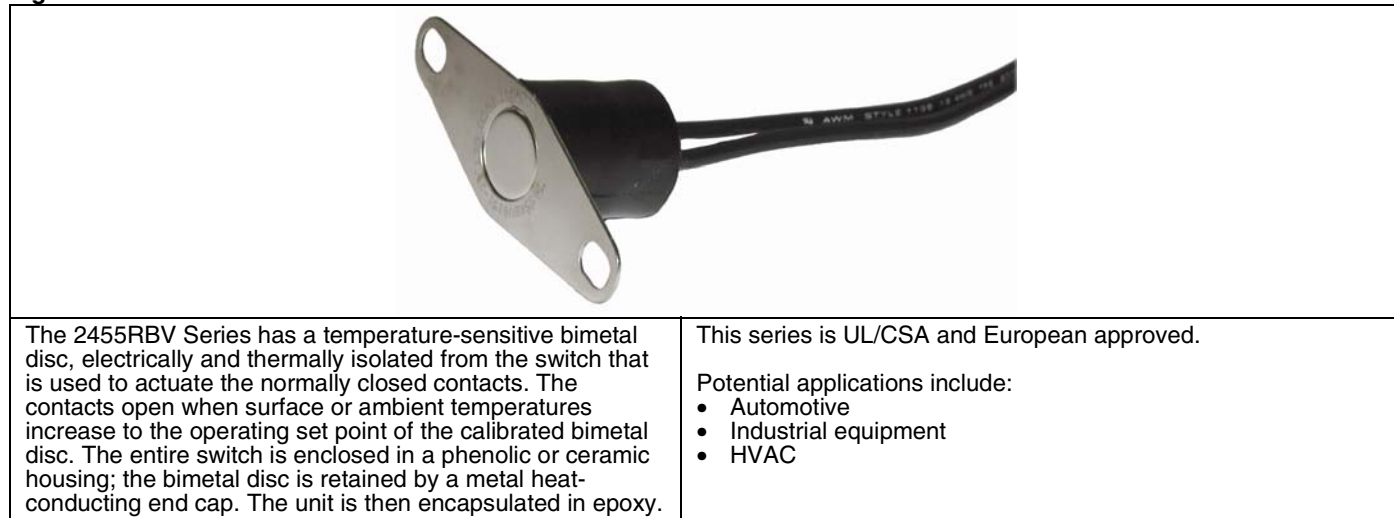

The 2455RBV Series has a temperature-sensitive bimetal disc, electrically and thermally isolated from the switch that is used to actuate the normally closed contacts. The contacts open when surface or ambient temperatures increase to the operating set point of the calibrated bimetal disc. The entire switch is enclosed in a phenolic or ceramic housing; the bimetal disc is retained by a metal heat-conducting end cap. The unit is then encapsulated in epoxy.

This series is UL/CSA and European approved.

Potential applications include:

- Automotive
- Industrial equipment
- HVAC

Table 17. 2455RBV Series Standard Temperature Characteristics

| Operating Temperature Range | Tolerance | | Standard Mean Differential °C [°F] |
|---|-----------------|------------------|---------------------------------------|
| | Open °C [°F] | Close °C [°F] | |
| -12,2 °C to 26,7 °C [10 °F to 80 °F] | ±4 [±7] | ±6 [±10] | 17 to 44 [30 to 80] |
| | ±3 [±6] | ±4 [±8] | 14 to 28 [25 to 50] |
| | ±3 [±5] | ±4 [±8] | 11 to 22 [20 to 40] |
| 27,2 °C to 105 °C [81 °F to 221 °F] | ±3 [±6] | ±6 [±10] | 17 to 44 [30 to 80] |
| | ±3 [±5] | ±4 [±8] | 11 to 28 [20 to 50] |

Commercial Thermostats

Table 18. 2455RBV Series Specifications

| Characteristic | Parameter |
|------------------------------|---|
| Switch type | SPST |
| Reset type | automatic |
| Amperage | see Table 19 |
| Voltage | 120 Vac to 250 Vac |
| Operating temperature range | 0 °C to 105 °C [32 °F to 221 °F] |
| Environmental exposure range | -18 °C to 126.6 °C [0 °F to 260 °F] |
| Materials: | |
| Boot | nylon, with epoxy filled or injection molded |
| Base | internal 2455RC ceramic or 2455R phenolic |
| Contacts | silver alloy |
| Terminals | plated steel with wires |
| Closure | aluminum, brass, or stainless steel |
| Brackets | stainless steel |
| Approvals | UL File SA4469, CSA File LR21048. |
| Weight | 6.5 g [0.23 oz] (does not include brackets or wire leads) |

Table 19. 2455RBV Series Contact Ratings

| Life Cycles | 120 Vac | 240 Vac |
|-------------|---------------------------------------|---------------------------------------|
| 100,000 | 15 A resistive | 10 A resistive |
| 6,000 | 5.8 FLA 34.8 LRA | 2.9 FLA 17.4 LRA |
| 100,000 | 4.4 FLA 26.4 LRA 125 VA pilot duty | 2.2 FLA 13.2 LRA 125 VA pilot duty |

Note: Additional contact ratings are available, please contact Honeywell.

Figure 11. 2455RBV Basic Dimensions



Figure 12. 2450A/2455RA Heat Detection Thermostats



The 2450A/2455RA Series is a single pole, single throw, snap-acting, non-adjustable thermostat designed for easy mounting in devices such as fire alarms, security devices and smoke detectors. A temperature-sensitive bimetal disc, electrically and thermally isolated from the switch, is used to actuate the normally-closed contacts. Contacts open when surface or ambient temperatures increase to the operating set point of the calibrated bimetal disc. Devices are UL recognized and designed for use in both photoelectric and ionization type smoke detectors. Thermostats are available with and without collectors and meet UL spacing requirements for 15 ft, 30 ft and 50 ft. They are available to open or close on a temperature rise of 47 °C [117 °F] to 107 °C [225 °F]. Devices feature gold contacts for low voltage requirements and are epoxy sealed at the cap and terminal for long storage life of the application. Collectors are available in silver, black, beige, gold or bronze finishes.

All versions are UL approved.

Potential applications:

- Smoke alarm/heat detectors in industrial, residential and commercial

NOTICE

Final approval of a fire detection system is determined by UL as outlined in UL #521 and UL #217 for the suitability of the combination of the thermostat (2450A/2455RA) and the user's mounting base, together with its intended application of the total fire detection system. To assist the use with design and testing , a minimum of 0.25 in extension beyond the housing is recommended.

Table 20. 2450A/2455RA Series Standard Temperature Characteristics

| Detection (Close on Rise) | | Release (Open on Rise) | |
|---------------------------|-----------------|------------------------|-----------------|
| Close °C [°F] | Open °C [°F] | Open °C [°F] | Close °C [°F] |
| 47 ±3 [117±5] | 30 min [85 min] | 57 ±3 [117 ±5] | 30 min [85 min] |
| 57 ±3 [135 ±5] | 32 min [90 min] | 57 ±3 [135 ±5] | 32 min [90 min] |
| 69 ±3 [156 ±5] | 32 min [90 min] | 69 ±3 [156 ±5] | 32 min [90 min] |
| 85 ±4 [185 ±7] | 32 min [90 min] | 85 ±4 [185 ±7] | 32 min [90 min] |
| 107 ±4 [225 ±7] | 32 min [90 min] | 107 ±4 [225 ±7] | 32 min [90 min] |

Notes:

- Additional switches can be provided as long as they fall between 47,2 °C to 107,2 °C [117 °F to 225 °F] close on rise or open or rise.
- Please consult Honeywell for tolerances and temperatures not listed.

Commercial Thermostats

Table 21. 2450A/2455RA Series Specifications

| Characteristic | Parameter |
|------------------------------|--|
| Switch type | SPST |
| Reset type | automatic |
| Amperage | 3 A |
| Voltage | 120 Vac |
| Operating temperature range | 47,2 °C to 107,2 °C [117 °F to 225 °F] |
| Environmental exposure range | -0 °C to 150 °C [32 °F to 302 °F] |
| Materials: | |
| Base | phenolic |
| Contacts | gold flash |
| Terminals | unplated brass, plated brass |
| Closure | aluminum |
| Brackets | aluminum |
| Approvals | UL File S1015 and S1389; Guide USCV2 and TAOZ2, UL Standard #521, #217 |
| Weight | 6 g [0.21 oz] (does not include brackets) |

Figure 13. 2450A/2455RA Basic Dimensions

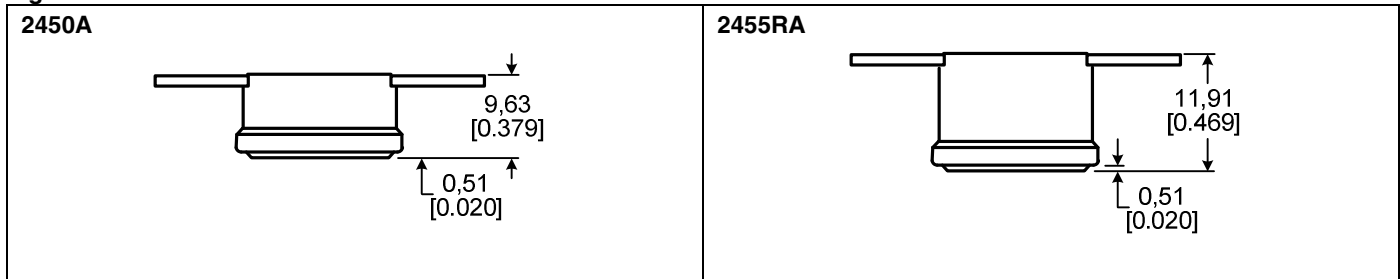

Figure 14. 2450A/2455RA Collector

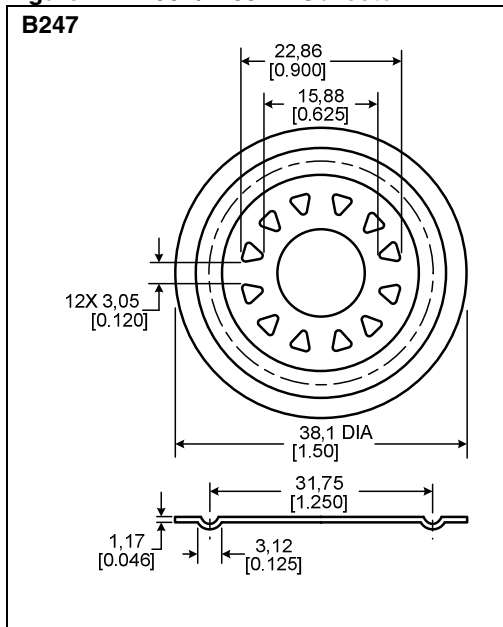

Figure 15. 2450A and 2455RA Spacing



Figure 16. 2450R/2455R/2450RC/2455RC/2450HR/2450RCH Series “One Shot” Thermostats

| | |
|---|---|
|  | |
| <p>The 2450R/2455R/2450RC/2455RC/2450HR/2450RCH Series “One Shot” is a single pole, single throw, snap-acting, non-adjustable thermostat designed as a high limit device for applications where automatically resettable thermostats are not desirable. A temperature-sensitive bimetal disc, electrically and thermally isolated from the switch, is used to actuate the normally-closed contacts. Contacts open when surface or ambient temperatures increase to the operating set point of the calibrated bimetal disc. The entire switch is enclosed in a housing; the bimetal disc is retained by a metal heat-conducting end cap. The circuit remains open above the room ambient temperature and will reset below -35 °C [-31 °F]. For increased sensitivity, an exposed disc may be specified. A variety of mounting brackets and terminals is available.</p> | <p>All versions are UL/CSA approved and European approved.</p> <p>Potential applications include:</p> <ul style="list-style-type: none"> • Power supplies • Appliances • Medical equipment • Water heaters • Office automation • Industrial equipment • HVAC equipment |

Table 22. 2450R/2455R/2450RC/2455RC/2450HR/2450RCH Series “One Shot” Standard Temperature Characteristics

| Operating Temperature Range | Tolerance °C [°F] |
|-------------------------------------|-------------------|
| 52 °C to 93 °C [125 °F to 200 °F] | 5 [8] |
| 94 °C to 121 °C [201 °F to 250 °F] | 6 [10] |
| 122 °C to 149 °C [251 °F to 300 °F] | 7 [12] |
| 150 °C to 177 °C [301 °F to 350 °F] | 8 [15] |
| 177 °C to 204 °C [351 °F to 400 °F] | 10 [18] |
| 205 °C to 232 °C [401 °F to 450 °F] | 11 [20] |
| 232 °C to 260 °C [451 °F to 500 °F] | 14 [25] |

Commercial Thermostats

Table 23. 2450R/2455R/2450RC/2455RC/2450HR/2450RCH Series “One Shot” Specifications

| Characteristic | Parameter |
|------------------------------|---|
| Switch type | SPST |
| Reset type | One Shot |
| Amperage | see Table 24 |
| Voltage | 120 Vac to 250 Vac |
| Operating temperature range | 2450R/2455R/2450HR/2450RCH: 52 °C to 150 °C [125 °F to 302 °F] 2450RC/2455RC: 52 °C to 260 °C [125 °F to 500 °F] |
| Environmental exposure range | 2450R/2455R/2450HR/2450RCH: 17.8 °C to 177 °C [0 °F to 350 °F] 2450RC/2455RC: 17.8 °C to 287 °C [125 °F to 550 °F] |
| Materials: | |
| Base | phenolic or ceramic |
| Contacts | silver alloy |
| Terminals | unplated brass, plated brass or steel |
| Closure | aluminum, brass, stainless steel |
| Brackets | stainless steel |
| Approvals | UL File E36103, CSA File LR43279 |
| Weight | 6 g [0.21 oz] (does not include brackets or lead wires) |

Table 24. 2450R/2455R/2450RC/2455RC/2450HR/2450RCH Series “One Shot” Contact Ratings

| Cycles | 120 Vac | 240 Vac | 277 Vac |
|--------|----------------|----------------|----------------|
| 1 | 15 A resistive | 10 A resistive | 10 A resistive |

Notes:

- Resets below -35 °C [-31 °F].
- Additional contact ratings are available. Please consult Honeywell.

Figure 17. 2450R/2455R/2450RC/2455RC/2450HR/2450RCH Series “One Shot” Basic Dimension



REDI-TEMP THERMOSTATS

REDI-TEMP thermostats are pre-configured as shown and are readily available.

Figure 18. 3455RC REDI-TEMP Series (See page 6 for specifications and potential applications.)



Table 25. 3455RC REDI-TEMP Series Open on Rise

| Catalog Listing | Open Temp. °C [°F] | Open Tolerance °C [°F] | Close Temp. °C [°F] | Close Tolerance °C [°F] |
|-----------------|--------------------|------------------------|---------------------|-------------------------|
| 3455RC-100-220 | 18 [65] | ±3 [±5] | -1 [30] | ±5 [±8] |
| 3455RC-100-221 | 24 [75] | ±3 [±5] | 4 [40] | ±5 [±8] |
| 3455RC-100-222 | 29 [85] | ±3 [±5] | 13 [55] | ±5 [±8] |
| 3455RC-100-223 | 35 [95] | ±3 [±5] | 18 [65] | ±5 [±8] |
| 3455RC-100-224 | 41 [105] | ±3 [±5] | 24 [75] | ±5 [±8] |
| 3455RC-100-225 | 46 [115] | ±3 [±5] | 29 [85] | ±5 [±8] |
| 3455RC-100-226 | 52 [125] | ±3 [±5] | 35 [95] | ±5 [±8] |
| 3455RC-100-227 | 57 [135] | ±3 [±5] | 41 [105] | ±5 [±8] |
| 3455RC-100-228 | 63 [145] | ±3 [±5] | 46 [115] | ±5 [±8] |
| 3455RC-100-229 | 68 [155] | ±3 [±5] | 52 [125] | ±5 [±8] |
| 3455RC-100-230 | 73 [165] | ±3 [±5] | 57 [135] | ±5 [±8] |
| 3455RC-100-231 | 79 [175] | ±3 [±5] | 63 [145] | ±5 [±8] |
| 3455RC-100-232 | 85 [185] | ±3 [±5] | 68 [155] | ±5 [±8] |
| 3455RC-100-233 | 91 [195] | ±3 [±5] | 73 [165] | ±5 [±8] |
| 3455RC-100-234 | 96 [205] | ±4 [±6] | 79 [175] | ±5 [±8] |
| 3455RC-100-235 | 102 [215] | ±4 [±6] | 85 [185] | ±5 [±8] |
| 3455RC-100-236 | 107 [225] | ±4 [±6] | 91 [195] | ±5 [±8] |
| 3455RC-100-237 | 113 [235] | ±4 [±6] | 96 [205] | ±5 [±8] |
| 3455RC-100-238 | 118 [245] | ±4 [±6] | 102 [215] | ±5 [±8] |
| 3455RC-100-239 | 124 [255] | ±4 [±7] | 107 [225] | ±5 [±8] |
| 3455RC-100-240 | 135 [275] | ±4 [±7] | 118 [245] | ±5 [±8] |
| 3455RC-100-241 | 146 [295] | ±4 [±7] | 129 [265] | ±5 [±8] |
| 3455RC-100-242 | 157 [315] | ±6 [±10] | 135 [275] | ±8 [±15] |

Table 26. 3455RC REDI-TEMP Series Close on Rise

| Catalog Listing | Close Temp. °C [°F] | Close Tolerance °C [°F] | Open Temp. °C [°F] | Open Tolerance °C [°F] |
|-----------------|---------------------|-------------------------|--------------------|------------------------|
| 3455RC-100-243 | 21 [70] | ±5 [±8] | 2 [35] | ±3 [±5] |
| 3455RC-100-244 | 32 [90] | ±5 [±8] | 16 [60] | ±3 [±5] |
| 3455RC-100-245 | 43 [110] | ±5 [±8] | 27 [80] | ±3 [±5] |
| 3455RC-100-246 | 54 [130] | ±5 [±8] | 38 [100] | ±3 [±5] |
| 3455RC-100-247 | 66 [150] | ±5 [±8] | 49 [120] | ±3 [±5] |
| 3455RC-100-248 | 77 [170] | ±5 [±8] | 60 [140] | ±3 [±5] |
| 3455RC-100-249 | 88 [190] | ±5 [±8] | 71 [160] | ±3 [±5] |
| 3455RC-100-250 | 99 [210] | ±5 [±8] | 82 [180] | ±4 [±6] |
| 3455RC-100-251 | 110 [230] | ±5 [±8] | 93 [200] | ±4 [±6] |

Note: Materials and contact ratings are the same as those for 2455RC.

Commercial Thermostats

MOUNTING HARDWARE

Figure 19. Brackets



Figure 19. Brackets (Continued)



Figure 20. Brass Mounting Studs



Commercial Thermostats

Figure 21. Terminals



Figure 21. Terminals (Continued)

